

服务热线：0510-8884 8008

专业磁电装备供应商
安全 便捷 高效



 **翔源机械**
XIANGYUAN MACHINERY



IMAGE TODAY DESIGN SOURCE]

We are the first Korean family that image producer in Korea and
now have 20,000 images in Air Processor series and Green series.
Our first images are well known in Korea design and advertising industry and
the market share of our images is over 70 percent in local Korean company.



以质量求生存，以信誉求发展。

创优质的产品，做全面的服务。

——服务宗旨



专业磁电装备供应商
安全 便捷 高效

目录 CONTENT

▶ 企业介绍02

▶ 企业资质03

▶ 产品介绍

机床吸盘

标准电磁吸盘	04/05
密极电磁吸盘 (两款: 全密/不全密)	06
纵极电磁吸盘 (两款: 密极/强力)	06
强力电磁吸盘	07
磨刀机电磁吸盘	08
回转电磁吸盘	08
电磁吸盘充退磁控制器 (外置、内置)	09
圆形电磁吸盘	10/11
密极永磁吸盘	12
超强力永磁吸盘	13
单倾、双倾永磁吸盘	14
纵向正弦永磁吸盘	14
双面永磁吸盘	15
回转永磁吸盘	15
钨钢永磁吸盘	16
超薄永磁吸盘	16
一体正磁吸盘	16
密极圆形永磁吸盘	17
强力圆形永磁吸盘	17
辐射圆形永磁吸盘	17
铣削电永磁吸盘	18
磨床电永磁吸盘	19
圆形电永磁吸盘	20

玻璃夹具电永磁吸盘	21
导轨电永磁吸盘	21
道岔永磁吸盘	22
电永磁脉冲式控制器	22
注塑机电永磁电控	23
电磁 (永磁) 导磁块	24
电永磁吸盘导磁块	24



► 翔源简介

无锡翔源机械设备有限公司座落于美丽富饶的长江三角洲（中国·江苏·无锡），紧依优美的太湖，毗邻南京、上海、浙江，交通便捷。本公司为江苏省民营高科企业，并通过ISO 9001:2015质量管理体系认证以及CE欧盟认证；拥有专业磁电专家及技术人员，提供安全、便捷、高效的磁电装备。

本公司主要产品有——电磁吸盘系列、电永磁吸盘系列、永磁吸盘系列、永磁起重器系列、起重电磁铁系列、退磁器(消磁器)系列以及控制器等相关配套产品。产品广泛应用于冶金、机械、造船、电力、矿山、汽车制造、轨道交通等行业，畅销全国多个省市自治区，并出口到欧洲、美国、日本、韩国、东南亚等国家和地区....

公司长期坚持“以质量求生存，以信誉求发展”的经营理念，严格监控产品质量，确保质量满足用户要求，同时严格执行“三包”履行质量保证承诺。本公司产品质量稳定，“翔源”已经注册国家商标。

本公司作为国内专业磁电设备供应商，拥有全面的磁电系列产品，提供专业的磁电技术解决方案！

Wuxi Xiangyuan Machinery Equipment Co., Ltd. is located in the beautiful and rich Yangtze River Delta (Wuxi, Jiangsu, China), close to the beautiful Taihu lake, adjacent to Nanjing, Shanghai, Zhejiang, convenient transportation. The company is a private high tech enterprise in Jiangsu Province, and has passed ISO9001:2015 quality management system certification and CE European Union certification; with professional magneto-electric experts and technicians, providing safe, convenient and efficient magneto-electric equipment.

The main products of our company are — Electromagnetic chuck series, Electro-Permanent Magnetic Chuck series, Magnetic chuck series, Lifting Magnet series, Lifting Electromagnet series, Demagnetizing device series, Rectifying controller and other related products. The products are widely used in metallurgy, machinery, shipbuilding, electric power, mine, automobile manufacturing, rail transportation and other industries. It is popular in all the provinces and autonomous regions; and exported to Europe, United States, Japan, South Korea, Southeast Asia and other countries and regions.

The company adheres to the business philosophy of "Survive by quality and develop with credibility" for a long time, strictly monitoring product quality and ensuring quality to meet user requirements, at the same time strictly implement "Three Guarantees" to fulfill the quality assurance commitment. Our product quality is stable, "Xiang yuan" has registered a national trademark.

As a professional supplier of magneto electrical equipment, our company has comprehensive magnetic and electrical products, and provide professional solutions for magneto-electric technology.



► 企业资质 Enterprise qualification

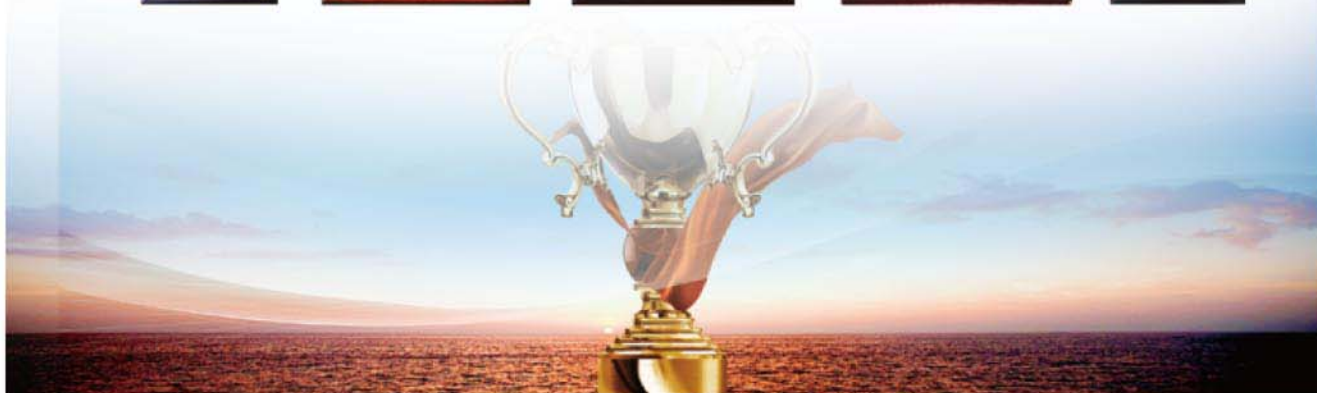

▶ X11标准电磁吸盘

产品介绍：标准电磁吸盘主要用于平面磨床的磁力工作台，吸持导磁性材料进行加工，独特的线圈设计，吸力非常均匀。吸力 $\geq 100\text{N}/\text{cm}^2$ ，高刚性、高精度，热变形小。适用于不易装夹的工件，使加工过程安全，便捷，高效。

Product introduction: standard rectangular electro-magnetic chuck is mainly used for surface grinding machine, holding onto magnetic materials for grinding, the unique design of coil suction is very uniform. Suction $\geq 100\text{N}/\text{cm}^2$, high rigidity, high precision, thermal deformation is small. Apply to lamping difficult workpiece, make the machining process safety, convenient, efficient.

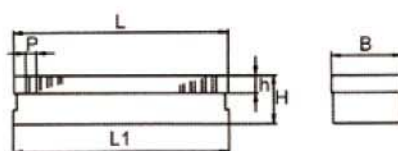

标准电磁吸盘参数表

产品规格：

型号 Model	主要尺寸mm Dimensions			极距P	电压V Voltage	电流A Current	功率W Power	净重KG Net WT	包装箱外形尺寸CM Overall size
	长L	宽B	高H						
X11 150*400	400	150	80	15	110	0.45	50	31	58*25*18
X11 200*400	400	200	80	15	110	0.8	88	40	58*29*18
X11 200*560	560	200	110	22	110	0.93	103	83	76*29*20
X11 200*630	630	200	110	22	110	1.14	125	90	85*29*20
X11 200*800	800	200	110	22	110	1.2	132	107	105*29*20
X11 200*1000	1000	200	110	22	110	1.25	138	134	125*29*20
X11 250*600	600	250	110	22	110	1.2	132	98	80*34*20
X11 300*600	600	300	110	22	110	1.4	154	124	80*38*20
X11 300*680	680	300	110	22	110	1.45	160	136	90*38*20
X11 300*800	800	300	110	22	110	1.84	185	156	100*40*20
X11 300*1000	1000	300	110	22	110	1.94	213	200	118*40*20
X11 300*1500	1500	300	110	22	110	2.1	231	300	168*40*20
X11 300*1600	1600	300	115	22	110	2.2	233	322	178*40*22
X11 320*800	800	320	110	22	110	1.84	208	176	98*42*20

产品规格：

型号 Model	主要尺寸mm Dimensions			极距P	电压V Voltage	电流A Current	功率W Power	净重KG Net WT	包装箱外形尺寸CM Overall size
	长L	宽B	高H						
X11 320*1000	1000	320	110	22	110	2.26	249	220	118*42*20
X11 320*1250	1250	320	110	22	110	1.96	216	268	145*42*20
X11 320*1600	1600	320	115	22	110	2.2	233	343	178*42*22
X11 400*630	630	400	110	22	110	1.2	136	169	83*50*20
X11 400*800	800	400	110	22	110	1.9	209	200	98*50*20
X11 400*1000	1000	400	110	22	110	2	220	268	118*50*20
X11 400*1200	1200	400	110	22	110	2.1	231	321	138*50*20
X11 400*1600	1600	400	115	22	110	3.4	370	428	178*50*22
X11 400*1800	1800	400	115	22	110	6	660	480	198*50*22
X11 500*800	800	400	110	22	110	2.7	297	270	98*60*20
X11 500*1000	1000	500	115	22	110	3.4	373	360	118*60*22
X11 500*1200	1200	500	115	22	110	3.3	330	370	138*60*22
X11 500*1600	1600	500	115	22	110	4.5	498	570	178*60*22
X11 500*2000	800	600	115	22	110	5.32	585	705	228*60*22
X11 600*1000	1000	600	115	22	110	2.1	231	360	118*70*22
X11 600*1200	1200	600	115	22	110	4.5	495	432	138*70*22
X11 600*1600	1600	600	115	22	110	4.5	495	678	178*70*22
X11 600*2000	2000	600	115	22	110	5.4	594	847	218*70*22
X11 630*1000	1000	630	115	22	110	4	440	400	118*75*22
X11 630*1250	1250	630	115	22	110	4.8	528	450	145*75*22
X11 630*1600	1600	630	115	22	110	5.14	565	730	178*75*22
X11 630*2000	2000	630	115	22	110	7	770	950	218*75*22
X11 700*1000	1000	700	115	22	110	2	220	550	100*80*22
X11 800*1000	1000	800	115	22	110	2.48	273	550	118*90*22
X11 800*1600	1600	800	115	22	110	6.8	550	850	168*90*22
X11 1000*1000	1000	1000	115	22	110	6.8	429	78	118*110*22
X11 1000*1800	1800	1000	115	22	110	10	1100	1200	200*120*22

► XM11密极电磁吸盘

产品介绍：密极电磁吸盘主要针对于吸持小型，薄型等工件进行加工，加密的磁力线设计使吸力更强更均匀。吸力 $\geq 150\text{N}/\text{cm}^2$ ，高刚性、高精度，热变形小。此款为普通电磁吸盘的加强型，对于电磁吸盘要求更高，使用范围更广的加工要求所设计，使加工过程更安全，便捷，高效。

Product introduction: powerful magnetic chuck is mainly for holding a small, thin workpiece processing, such as encryption of the magnetic field lines design to make it stronger suction more evenly. Suction $\geq 150\text{N}/\text{cm}^2$, high rigidity, high precision, small thermal deformation. make the machining process safety, convenient, efficient.



A型



B型



产品规格：

型号 Model	主要尺寸mm Dimensions			极距P	电压V Voltage	电流A Current	功率W Power	净重KG Net WT	包装箱外形尺寸CM Overall size
	长L	宽B	高H						
XM11 200*400	400	200	110	5	110	0.95	123	62	60*30*20
XM11 200*450	450	200	110	5	110	1.03	113	66	65*30*20
XM11 200*500	500	200	110	5	110	1.23	135	72	70*30*20
XM11 200*560	560	200	110	5	110	1	110	80	76*30*20
XM11 200*600	600	200	110	5	110	1	110	86	76*30*20
XM11 200*630	630	200	110	5	110	1.1	121	88	83*30*20
XM11 250*500	500	250	110	5	110	1.2	132	92	70*35*20
XM11 250*600	600	250	110	5	110	1.7	185	118	80*35*20
XM11 300*600	600	300	110	5	110	1.88	207	144	80*40*20
XM11 300*680	680	300	110	5	110	1.5	160	150	88*40*20
XM11 300*800	800	300	115	5	110	2	220	172	100*40*21
XM11 300*1000	1000	300	115	5	110	2.2	342	223	120*40*21
XM11 320*800	800	320	115	5	110	2.1	231	185	88*42*20
XM11 320*1000	1000	320	115	5	110	2.35	258	238	120*42*21
XM11 400*800	800	400	115	5	110	2.3	253	235	88*50*21
XM11 400*1000	1000	400	115	5	110	2.88	316	290	120*50*21

备注：其他规格可按用户需求定制，详情请来电咨询。

使用建议：有两种安装方式（通孔/压块），请根据安装方式选购产品；并有A/B两种密极电磁吸盘型号（如图）。

► XB11纵极强力电磁吸盘/XB91纵极密极电磁吸盘

产品介绍：纵极强力型电磁吸盘用于吸住较大工件加工，纵极密极型电磁吸盘适用于吸持薄小工件。对横向摆放的窄条状工件尤为适用，使加工过程更安全，便捷，高效。

Product introduction: longitudinal Powerful magnetic chuck is used to absorb large workpiece processing, Longitudinal fine-pole magnetic chuck is suitable for holding thin & small workpiece. Especially true for horizontally placed narrow strips artifacts that make the process more safety, convenient, efficient.



产品规格：

型号 Model	主要尺寸mm Dimensions			极距P	电压V Voltage	电流A Current	功率W Power	净重KG Net WT	包装箱外形尺寸CM Overall size
	长L	宽B	高H						
XB11-200*400	400	200	90	5	110	0.69	76	36	60*30*19
XB11-200*450	450	200	90	5	110	0.9	99	40	65*30*19
XB11-200*500	500	200	110	5	110	1.1	121	46	70*30*20
XB11-200*600	600	200	110	5	110	1.31	144	55	80*30*20
XB11-300*600	600	300	110	5	110	1.52	167	110	80*40*20
XB11-300*800	800	300	110	5	110	1.86	204	152	100*40*25
XB11-300*1000	1000	300	110	5	110	2	220	200	120*40*25
XB11-300*1600	1600	300	110	5	110	4.2	462	320	180*40*25
XB11-320*1000	1000	320	110	5	110	2	220	215	120*42*25
XB11-400*630	630	400	110	5	110	2.38	262	170	83*50*25
XB11-400*800	800	400	110	5	110	2.7	297	220	100*50*25
XB11-400*1000	1000	400	110	5	110	3	330	260	120*50*25

备注：其他规格可按用户需求定制，详情请来电咨询。

使用建议：有两种安装方式（通孔/压块），请根据安装方式选购产品；并有纵极强力型与纵极密极型。

► X91强力电磁吸盘

产品介绍：强力电磁吸盘和各种铣床、刨床（立式铣床、龙门铣床、数控铣床、刨床）配套使用，吸力 $\geq 180\text{N}/\text{cm}^2$ ，进行重切削最有效。有效防止刀具磁化，提高加工精度，延长刀具寿命，节省装夹时间；该系列磁盘是提高生产效率，降低工人劳动强度的理想选择。使加工过程更安全，便捷，高效。

Product introduction:powerful magnetic chuck and a variety of milling machine (Suction $\geq 180\text{ N}/\text{cm}^2$) for heavy cutting is the most effective. Effectively prevent tool magnetization, improve the machining precision, prolong tool life, save the clamping time. Make the process more safety, convenient and efficient.

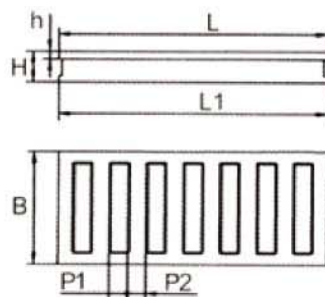

产品规格：

型号 Model	主要尺寸mm Dimensions			极距P	电压V Voltage	电流A Current	功率W Power	净重KG Net WT	包装箱外形尺寸CM Overall size
	长L	宽B	高H						
X91 200*560	560	200	120	100	110	1.5	165	79	76*30*20
X91 200*600	600	200	120	100	110	1.8	198	82	80*30*20
X91 300*600	600	300	120	110	110	2.2	242	132	80*40*20
X91 300*680	680	300	120	110	110	2.5	275	156	88*40*20
X91 300*800	800	300	125	110	110	3	330	202	100*40*20
X91 300*1000	1000	300	125	110	110	3.3	363	226	120*40*20
X91 400*800	800	400	125	120	110	3.5	385	252	100*50*20
X91 400*1000	1000	400	125	120	110	4.2	462	310	120*50*20
X91 500*1000	1000	500	128	120	110	5.5	605	360	120*60*30
X91 500*1200	1200	500	128	120	110	6.2	682	420	140*60*30
X91 500*1500	1500	500	128	120	110	6.5	748	520	170*60*30
X91 600*1000	1000	600	130	120	110	5.6	616	420	120*70*30
X91 600*1200	1200	600	130	120	110	6	660	520	140*70*30
X91 600*1500	1500	600	130	120	110	6.6	726	650	170*70*30
X91 600*1800	1800	600	130	120	110	7.5	825	720	200*70*30
X91 800*1000	1000	800	135	122	110	6	660	580	120*90*30
X91 800*1500	1500	800	135	122	110	7.2	792	890	170*90*30
X91 800*1800	1800	800	135	122	110	8	880	1050	200*90*30

备注：其他规格可按用户要求定制；详情请来电咨询。
 使用建议：有两种安装方式（通孔/压块），请根据安装方式选购产品。

► XZ11磨刀机电磁吸盘

产品介绍：磨刀机专用电磁吸盘吸力均匀，定位精确，可以使用于各种磨刀机，如：木工磨刀机，切纸磨刀机，使加工过程更安全，便捷，高效。

Product introduction: grinding electromagnetic chuck suction uniform, accurate positioning, can use in a variety of grinding machine, such as: wood-working knife grinder, cutter grinder, machining process more safe, convenient and efficient.

产品规格：

型号 Model	主要尺寸mm Dimensions			极距P	电压V Voltage	电流A Current	功率W Power	净重KG Net WT	包装箱外形尺寸CM Overall size
	长L	宽B	高H						
XZ11-120*1400	1400	120	120	22	110	1.54	169	126	160*22*22
XZ11-120*1600	1600	120	120	22	110	1.84	202	143	180*22*22
XZ11-140*1380	1380	140	130	22	110	1.52	167	186	158*24*23
XZ11-150*1400	1400	150	110	22	110	1.6	176	145	160*25*21
XZ11-160*1400	1400	160	110	22	110	1.77	195	150	160*26*21
XZ11-160*1600	1600	160	120	22	110	2.2	242	187	180*26*22
XZ11-180*1000	1000	180	110	22	110	1	110	124	120*28*21
XZ11-180*1500	1500	180	120	22	110	2	220	220	170*28*22
XZ11-190*1680	1680	190	130	22	110	2.3	253	265	188*29*23
XZ11-190*2200	2200	190	130	22	110	2.5	275	280	240*29*23
XZ11-200*1000	1000	200	110	22	110	1.25	138	132	120*30*21
XZ11-200*1470	1470	200	120	22	110	2.5	275	220	167*30*22
XZ11-200*1550	1550	200	120	22	110	2.5	275	236	175*30*22
XZ11-200*1600	1600	200	130	22	110	2.6	286	255	180*30*23
XZ11-200*1760	1760	200	130	22	110	2.65	291	280	196*30*23
XZ11-200*2270	2270	200	130	22	110	2.8	308	330	247*30*23

备注：其他规格可按用户需求定制，详情请来电咨询。

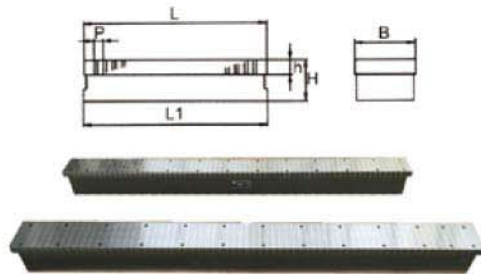

► XD11回转电磁吸盘

产品介绍：回转电磁吸盘主轴有刻度尺，用于调转定位角度，可对前、后加工角度调整，调整角度 $\pm 45^\circ$ ；吸盘与回转主轴为一体成型，定位精确，吸力均匀，可用于有角度工件的磨削、铣削、线切割、电火花等，使加工过程更安全，便捷，高效。

Product introduction: rotary electromagnetic chuck spindle is provided with a scale, switch orientation angle for, to adjust the angle of $\pm 45^\circ$; rotary spindle chuck and integrally, precise positioning, suction uniform. It can be used for angle of the work piece processing, make the machining process more safe, convenient and efficient.

产品规格：

型号 Model	主要尺寸mm Dimensions												总长 L2	总高 H2	电压 V	电流 A	功率 W	净重KG Net WT
	B1	L1	Le	H1	极距P	B2	G	h1	h2	P1	P2							
XD11-100*250	100	250	211	95	10(2+8)	100	14	91	18	50	38	380	145	110	0.3	33	21	
XD11-120*300	120	300	240	95	14(2+12)	100	14	91	18	50	38	430	145	110	0.44	48.4	29	
XD11-125*250	125	250	211	95	14(2+12)	100	14	91	18	50	38	380	145	110	0.32	35.2	25	
XD11-150*300	150	300	240	95	14(2+12)	100	14	91	18	50	38	430	145	110	0.4	44	37	
XD11-150*350	150	350	296	95	14(2+12)	100	14	91	18	50	38	480	145	110	0.42	46.2	41	
XD11-150*450	150	450	408	95	14(2+12)	100	14	91	18	60	38	600	145	110	0.5	55	51	
XD11-200*500	200	500	452	95	14(2+12)	100	16	120	20	60	43	650	170	110	0.9	122	76	
XD11-200*600	200	600	560	95	14(2+12)	100	16	120	20	60	43	750	170	110	1.1	121	89	
XD11-300*600	300	600	560	95	14(2+16)	120	16	120	20	80	48	790	170	110	1.4	154	106	
XD11-300*680	300	680	620	95	14(2+16)	120	16	120	20	80	48	870	170	110	1.45	159.5	120	
XD11-300*800	300	800	740	95	14(2+16)	120	16	120	20	80	48	960	170	110	1.84	202.4	155	

备注：其他可按用户需求定制，详情请来电咨询。

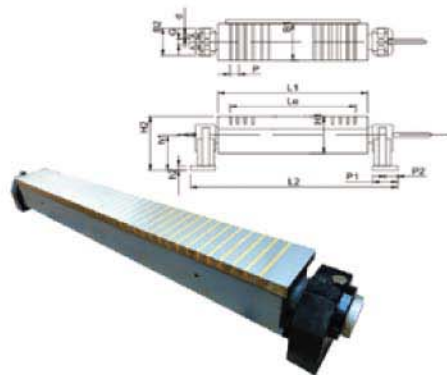

► WZ电磁吸盘充退磁控制器（外置）

产品介绍：

- 1、输出电流可实时显示；
- 2、充、退磁操作可通过三位开关进行；
- 3、充磁输出电流连续可调，可满足加工不同工件对磁力的要求；
- 4、根据给定的退磁曲线自动完成退磁过程，能使每块吸盘达到最佳的退磁效果；
- 5、具有自保护功能，在磁盘或线路出现故障时能有效自我保护，防止控制器损坏；

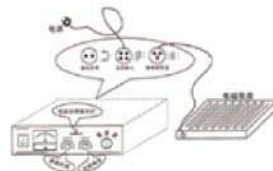

Product introduction:

- 1、the output current can be real-time display;
- 2、filling, demagnetization operation can be through the three switch;
- 3、magnetizing output current can be adjusted continuously;
- 4、according to the given demagnetization curve automatically complete demagnetization process;
- 5、has the protection function, on disk or line failure to protect themselves effectively, prevent damage of the controller.



台式



柜式

产品参数表：

型号	输入电压 (V)	输出电压 (V)	输出电流 (A)	退磁时间 (S)	磁盘故障指示
WZ-05/220 (台式)	AC-220	DC-0~110	5	3~12	有
WZ-10/220 (台式)	AC-220	DC-0~110	10	3~12	有
WZ-20/380 (柜式)	AC-380	DC-0~110	20	3~12	有
WZ-30/380 (柜式)	AC-380	DC-0~110	30	3~12	有
WZ-50/380 (柜式)	AC-380	DC-0~110	50	3~12	有

► KMX电磁吸盘充退磁控制器（内置）

产品介绍：

- 1、用集成电路控制，实现无触点输出，增加了可靠性；
- 2、充磁输出电流连续可调，可满足不同磨床吸盘加工不同工件对磁力的要求；
- 3、根据设定的退磁曲线自动完成退磁过程，能使每块吸盘达到最佳的退磁效果；
- 4、具有过压、过流、短路等保护功能；
- 5、具有欠电流保护功能，可通过主机和磁盘连锁，以保证设备和人员的安全；



Product introduction:

- 1、with integrated circuit control, the realization of non-contact output, increased reliability;
- 2、the magnetization output current continuously adjustable;
- 3、according to the given demagnetization curve automatically complete demagnetization process;
- 4、has over voltage, over current, short circuit protection function;
- 5、with less current protection function, can be through the host and disk interlocking to ensure the safety of equipment and personnel;

产品参数表：

型号	额定输入电压 (V)	额定输出电压 (V)	最大输出电流 (A)	退磁时间 (S)	备注
KMX-1.5/1LQ	AC-127	DC-0~110	1.5	3~18	适用M7130磨床
KMX-1.5/2LQ	AC-220	DC-0~110	1.5	3~18	适用M7130磨床
KMX-03/1-1	AC-127	DC-0~110	3	3~18	适用M7140磨床及M7460等磨床
KMX-03/2-1	AC-220	DC-0~110	3	3~18	适用M7140磨床及M7460等磨床
KMX-05/1-1	AC-127	DC-0~110	5	3~18	适用M7160磨床及M7475等磨床
KMX-05/2-1	AC-220	DC-0~110	5	3~18	适用M7160磨床及M7475等磨床
KMX-10/2-1	AC-220	DC-0~110	10	3~18	适用M74125等磨床
KMX-20/2-1	AC-220	DC-0~110	20	3~18	适用M74160及龙门磨
KMX-30/2-1	AC-220	DC-0~110	30	3~18	适用龙门磨
KMX-50/2-1	AC-220	DC-0~110	50	3~18	适用龙门磨



► X21圆形电磁吸盘

产品介绍：圆形电磁吸盘是圆台平面磨床的主要部件，用以吸持导磁性材料进行加工，吸力为 80 至 120N/cm²。圆形电磁吸盘可分为：同心圆型、直条密极型、梅花极型、辐射极型。

Product introduction: circular electromagnetic chuck is the main component of rotary surface grinder, magnetic materials used for holding processing, suction of 80-120N/cm². Circular electromagnetic suction cup can be divided into: concentric circle, straight bar, plum, and radiation.

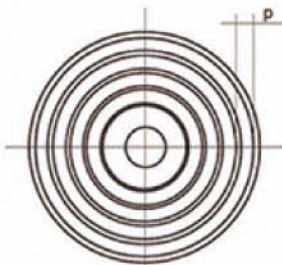

同心极型

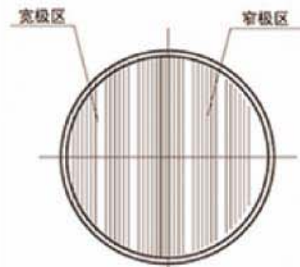

直条密极型

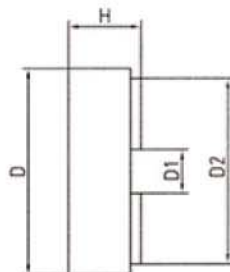

梅花极型

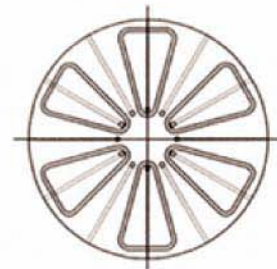

辐射极型

产品规格：

产品名称	型号	技术参数					台面形式 table type	净重kg Net WT
		外型尺寸 (mm)	电压 (V)	电流 (A)	功率 (W)	极距P		
		D×H	Voltage	Current	Power	Pole pitch		
圆型 电 磁 吸 盘	X21-250	Φ265×110	110	0.73	86	4+11	同心圆	40
	X21-320	Φ325×105	110	0.8	86	4+11	同心圆	65
	X21-400	Φ420×115	110	1.34	148	4+11	同心圆	110
	X21-500	Φ510×107	110	1.1	123	4+11	同心圆	160
	X21-550	Φ550×110	110	2	220	4+12	同心圆	200
	X21-600	Φ600×118	110	3.4	377	4+12	同心圆	250
	X21-780	Φ780×228	110	4.2	462	4+12	同心圆	700
	X21-800	Φ820×180	110	3.5	385	4+12	同心圆	705
	X21-1000CY	Φ1040×181	110	4.5	496	4+12	同心圆	1000
	X21-1250CY	Φ1290×210	100	13.9	1376	4+13	同心圆	1800
	X21-1400CY	Φ1408×238	110	10	1100	4+13	同心圆	2300
	X21-1600CY	Φ1680×210	110	14.6	1600	4+13	同心圆	3000
	X21-510Z	Φ510×107	110	1.1	123	4+1	直条密极	145
	X21-630Z	Φ640×135	110	3	330	4+1	直条密极	305
	X21-780Z	Φ780×200	110	5.1	561	4+1	直条密极	705
	X21-400M	Φ400×105	110	0.85	92		梅花极	100
	X21-500M	Φ560×128	110	1.96	216		梅花极	170
X21-630M	Φ677×138	110	3	330		梅花极	300	
辐 射 型 电 磁 吸 盘						磁极数	备注	
	X21-600F	Φ650×120	110	3	330	12	辐射极 Radial Pole	300
	X21-700F	Φ700×150	110	4	440	12		450
	X21-800F	Φ800×150	110	5	550	14		580
	X21-900F	Φ900×150	110	6	660	16		730
	X21-1000F	Φ1000×150	110	8	990	18		900
	X21-1300F	Φ1350×170	110	10	1000	24		1700
	X21-1600F	Φ1600×180	110	16	1760	24		2600
	X21-1800F	Φ1800×180	110	20	2200	36		3300
	X21-2500F	Φ2500×190	110	22	2450	40		6800

备注：其他规格可按用户要求定制；详情请来电咨询。
 使用建议：请根据安装方式选购产品。

► XM91密极永磁吸盘

产品介绍：密极永磁吸盘适用于平面磨床、火花机、线切割机床等。磁极间隙细密，磁力分布均匀，适合吸持薄小工件加工，吸力可达 $100\text{N}/\text{cm}^2$ 。

Product introduction: dense permanent magnetic chuck applicable to surface grinding machine, spark machine, line cutting machine tool, etc. The magnetic gap close, uniform magnetic distribution, suitable for holding thin & small workpiece processing, suction of up to 100 n/cm^2 .

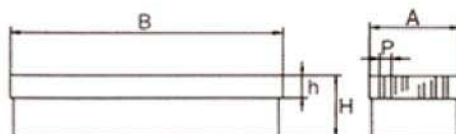
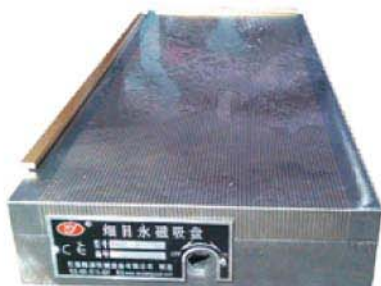
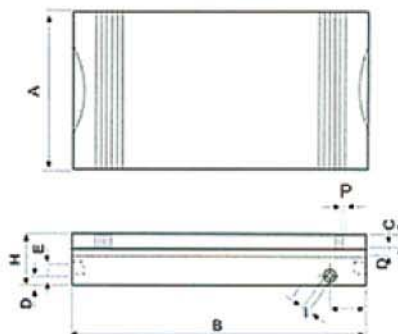

产品规格：

型号	主要尺寸(mm)			极距(mm)	磁力 (N/cm^2)	净重(kg)
	长B	宽A	高H			
XM91-100*175	175	100	45	1.5+0.5	≥ 100	6
XM91-125*250	250	125	45	1.5+0.5	≥ 100	10
XM91-150*150	150	150	45	1.5+0.5	≥ 100	7
XM91-150*300	300	150	45	1.5+0.5	≥ 100	14
XM91-150*350	350	150	45	1.5+0.5	≥ 100	17
XM91-150*400	400	150	45	1.5+0.5	≥ 100	21
XM91-150*450	450	150	45	1.5+0.5	≥ 100	23
XM91-200*400	400	200	45	1.5+0.5	≥ 100	28
XM91-200*450	450	200	45	1.5+0.5	≥ 100	31
XM91-200*500	500	200	45	1.5+0.5	≥ 100	35
XM91-200*560	560	200	45	1.5+0.5	≥ 100	39
XM91-250*500	500	250	45	1.5+0.5	≥ 100	44
XM91-300*500	500	300	45	1.5+0.5	≥ 100	52
XM91-300*600	600	300	45	1.5+0.5	≥ 100	63

备注：其他规格可按用户要求定制；详情请来电咨询。

使用建议：有两种安装方式（通孔/压块），请根据安装方式选购产品：

► XCM91超强力永磁吸盘

产品介绍：超强力永磁吸盘适用于 CNC 加工，精密铣床的铣削加工，独特的磁路设计，使吸力非常强大、均匀，高性能优质磁钢，可确保吸力长期稳定不变，吸力可达 $200\text{N}/\text{cm}^2$ 。

Product introduction:super powerful permanent-magnetic chuck is suitable for CNC machining, precision milling machine milling, unique magnetic circuit design, make the suction is very strong, uniform, high quality magnets, can ensure the long-term stable suction, suction of up to 200 n/cm^2 .

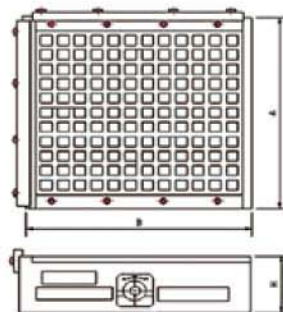
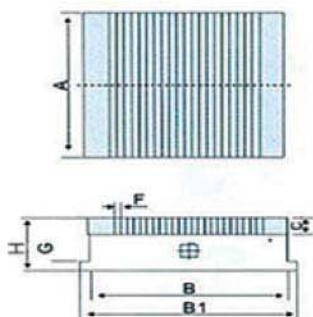

产品规格：

型号	主要尺寸 mm							净重
	A	B	B1	C	F	H	G	
XCM91 200x200	200	200	220	25	12+4	75	20	21
XCM91 200x300	200	300	320	25	12+4	75	20	32
XCM91 200x400	200	400	400	25	12+4	75	20	42
XCM91 250x250	250	250	270	25	12+4	75	20	33
XCM91 300x300	300	300	320	25	12+4	75	20	47
XCM91 300x400	300	400	420	25	12+4	75	20	63
XCM91 300x500	300	500	500	25	12+4	75	25	79
XCM91 300x600	300	600	600	25	12+4	75	25	95
XCM91 300x800	300	800	800	25	12+4	75	25	126
XCM91 350x350	350	350	370	25	12+4	75	25	65
XCM91 400x400	400	400	420	25	12+4	75	25	83
XCM91 400x500	400	500	500	25	12+4	75	25	106
XCM91 400x600	400	600	600	25	12+4	75	25	127
XCM91 400x800	400	800	800	25	12+4	75	25	168
XCM91 450x450	450	450	470	25	12+4	75	25	106
XCM91 500x500	500	500	520	25	12+4	75	25	132
XCM91 500x600	500	600	620	25	12+4	75	25	158
XCM91 600x600	600	600	620	25	12+4	75	25	190

备注：其他规格可按用户要求定制；详情请来电咨询。
 使用建议：有两种安装方式（通孔/压块），请根据安装方式选购产品；

► XM42单倾永磁吸盘

产品介绍：适用于各种平面磨床、放电加工机进行单面角度的精密磨削加工。

Product introduction: applicable to all kinds of surface grinding machine, discharge machine of single Angle precision grinding processing.



产品规格：

型号	主要尺寸 mm						加工角度	净重 N.W(kg)
	A	B	C	D	E	F		
XM42-100x175	100	175	85	75	20	0.5+1.5	0~45°	10
XM42-125x250	125	250	85	100	20	0.5+1.5	0~45°	12.5
XM42-150x150	150	150	85	100	20	0.5+1.5	0~45°	17
XM42-150x300	150	300	85	100	20	0.5+1.5	0~45°	25

更多型号规格可以定做。

备注：其他规格可按用户要求定制；详情请来电咨询。

► XM43双倾精密永磁吸盘

产品介绍：双倾精密永磁吸盘适用于各种平面磨床、放电加工机进行单面角度或两个角度的前、后或左的斜度精密磨削加工。使之调整精度更高。选用优质材料，吸力强，剩磁小，磁力分布均匀。开 / 关切换时磁力面的平面精度不变。磁极排列仅为 1.5mm, 可吸持较小零件。

Product introduction: new tilting dense permanent magnetic chuck, surface grinder, tool grinder, EDM ceiling to guide magnetic material in single side, double angle positioning processing, large angle slewing, it is more convenient to use.

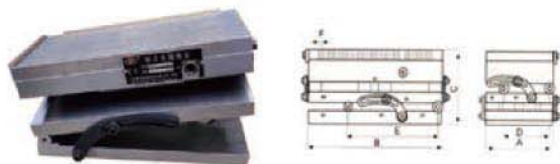

产品规格：

型号	主要尺寸						磨削角度	净重
	A	B	C	D	E	F		
XM43-100*175	100	175	115	75	100	0.5+1.5	0-45	12
XM43-125*250	125	250	115	75	150	0.5+1.5	0-45	20
XM43-150*150	150	150	115	100	100	0.5+1.5	0-45	15
XM43-150*300	150	300	115	100	150	0.5+1.5	0-45	32

更多规格可以定做。

► XL42纵向正弦永磁吸盘

产品介绍：纵向正弦永磁吸盘磁极排列仅为 1.5mm, 适用于吸持薄小工件，对横向摆放的窄条状工件尤为适用。适用加工左、右角度，角度 0~45°，广泛适用于各种工量具，模具，机床装配等。

Product introduction: the longitudinal sinusoidal permanent magnet sucker is suitable for all kinds of plane grinder, electric discharge machining machine for single angle precision grinding.



产品规格：

型号	主要尺寸				磁极间隔	净重 N.W(kg)
	A	B	C	D		
XL42-105x175	175	105	110	75	0.5+1.5	12KG
XL42-105x300	300	105	110	75	0.5+1.5	35KG
XL42-150x400	400	105	110	200	0.5+1.5	43KG

更多规格可根据客户需求制作。

► XM41双面永磁吸盘

产品介绍：双面式永磁吸盘两面具有磁性，具有两个磁性开关，可单独使用或者双面使用。双面式永磁吸盘由两块面板，两个板手，一个中间体，两套蓖子及相应大小的磁钢安装而成，它吸力均匀，适用于难以支持的工件进行磨削加工，比如对线切割机床的工件或者火花机机床的工件进行吸持加工。

Product introduction: double-sided type permanent magnetic sucking disc on both sides, with two magnetic switches can be used alone or use double-sided. Double-sided type permanent magnetic chuck by the two panels, two in hand, an intermediate, and two sets of castor bean and the size of the corresponding magnet installation and.

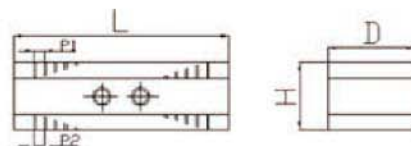

产品规格：

c	主要尺寸			磁极 P1 (P2)	净重 N.W(kg)
	长L	宽D	高H		
XM41-100x175	175	100	100	0.5+1.5	12
XM41-125x250	250	125	100	0.5+1.5	22
XM41-150x300	300	150	100	0.5+1.5	31
XM41-150x350	350	150	100	0.5+1.5	37
XM41-150x400	400	150	100	0.5+1.5	42
XM41-150x450	450	150	100	0.5+1.5	47
XM41-200x400	400	200	100	0.5+1.5	56
XM41-200x450	450	200	100	0.5+1.5	63
XM41-200x500	500	200	100	0.5+1.5	70
XM41-200x560	560	200	100	0.5+1.5	79

► XH42回转永磁吸盘

产品介绍：回转永磁吸盘旋转主轴有角度刻度，用于高精度前后角度磨削，前后可调角度 $\pm 90^\circ$ 。回转永磁吸盘适用于各种平面磨床，高精度角度磨削。

Product introduction: the rotary permanent magnetic chuck is provided with an angle scale, which is used for high precision before and after grinding, and the adjustable angle is 90 degrees. The rotary permanent magnet chuck is suitable for all kinds of plane grinder, the electric motor for high precision angle grinding.

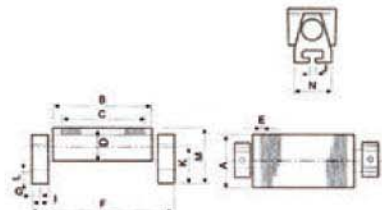

产品规格：

型号	主要尺寸(mm)														净重(kg)
	A	B	C	D	E	F	G	I	J	K	L	M	N		
XH42-100*175A	100	175	135	100	1.5(1+0.5)	292	25	50	14	103	50	163	100	18.5	
XH42-125*250A	125	250	250	100	1.5(1+0.5)	370	25	50	14	103	50	163	100	25	
XH42-150*150A	150	150	150	100	1.5(1+0.5)	270	25	50	14	103	50	163	100	21	
XH42-150*300A	150	300	300	100	1.5(1+0.5)	420	25	50	14	103	50	163	100	31	

更多规格可根据客户需求制作。

► XC钨钢永磁吸盘

产品介绍：钨钢吸盘采用高性能磁钢，适用于导磁性较弱的工件（如：钨钢、络 12、钴钢、石英及其他超硬材料等）。

Product introduction: tungsten steel sucker production magnet with high performance, applicable to the workpiece in weak magnetic guide (such as: tungsten steel, complex 12, cobalt, quartz and other superhard materials, etc.)

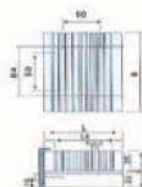
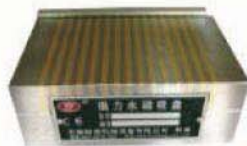

产品规格：

型号	磁力吸盘具体参数					吸力	重量
	B	L	LE	P	H		
XC-100*100	100	100	72	5(2+3)	50	210	3.9
XC-100*180	100	180	152	5(2+3)	50	210	7.1
XC-100*250	100	250	222	5(2+3)	50	210	10

更多规格可根据客户需求制作。

► X41超薄永磁吸盘



产品介绍：超薄永磁吸盘适用于投影仪、电火花加工、高速微量切削、磨床、刮研、钳工划线、电火花机床等，底座结构采用不锈钢材料制造，可长期防锈，防腐蚀，密封结构可以防水，整体高度很低，可以最大扩展设备的加工高度。

Product introduction: ultra thin permanent magnetic chuck used for projector, EDM, high-speed micro cutting, grinding, lapping, fitter, EDM machine, base structure made of stainless steel, long-term rust, corrosion, waterproof sealing structure, the overall height is very low, to extend equipment processing height.

产品规格：

型号	主要尺寸mm			极距P(mm)	吸力(N/cm ²)	重量
	长L	宽W	高H			
X41-150*300	300	150	28	10(2+8)	≥80	11
X41-150*350	350	150	35	10(2+8)	≥80	13
X41-150*400	400	150	40	10(2+8)	≥80	16
X41-150*450	450	150	40	10(2+8)	≥80	17.5

更多规格可根据客户需求定制。

► XG42一体正弦磁台

产品介绍：高精度正弦磁台是目前行业较新式的可倾永磁吸盘，精密度高，吸力强，稳定性持久，使用于各种薄小工件单面角度的高精度磨削加工。

Product introduction: high accuracy sine magnetic station is currently industry newer tilting permanent magnetic chuck, precision high, strong suction, lasting stability, used in high precision grinding of various thin small pieces of single angle.

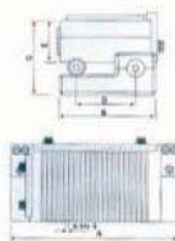

产品规格：

型号	主要尺寸 mm						加工角度 0~45°	净重 N.W(kg)
	A	B	C	D	E	P		
XG42-100x175	125	102	85	75	44	0.5+1.5	0~45°	11.5
XG42-150x150	200	152	85	100	44	0.5+1.5	0~45°	14.8
XG42-125x250	175	252	85	100	44	0.5+1.5	0~45°	21
XG42-150x300	350	152	85	100	44	0.5+1.5	0~45°	28

更多型号规格可以定制。

► XM51密极圆形永磁吸盘

产品介绍：用于各种平面磨床，万能工具磨床和车床等机床的辅助工具，用以吸持导磁性材料进行加工。

Product introduction: used for all kinds of surface grinding machine, universal tool grinder and lathe and other auxiliary tools, to hold the magnetic material for processing.

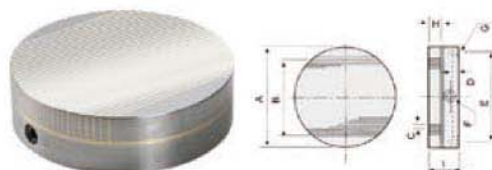

产品规格：

型号	主要尺寸									净重 kg
	A	B	C	D	E	F	G	H	I	
XM51-125	125	80	2(0.5+1.5) 或4(1+3)	2	105	10	M6	20	45	4.6
XM51-160	160	115		2	140	10	M8	20	45	6.6
XM51-200	200	155		2	180	10	M10	20	45	8.9
XM51-250	250	205		2	224	10	M10	20	45	15.3
XM51-300	300	255		2	260	10	M10	20	45	21.6
XM51-400	400	355		2	350	10	M10	20	48	42.5
XM51-500	500	455		2	450	10	M12	20	50	69
XM51-600	600	555		2	550	10	M12	20	50	99.8

更多规格可根据客户需求制作。

► X51强力圆形永磁吸盘

产品介绍：强力圆形永磁吸盘适用于小型立式平面磨床、外圆磨床、内圆磨床的磨削加工、车床的轻度切削加工。

Product introduction: the strong circular permanent magnetic chuck is suitable for the grinding process of small vertical plane grinder, cylindrical grinder, internal grinder and lathe.

产品规格：

型号	主要尺寸								磁极间距 P Pole pitch	净重KG
	D	H	h	C1	C2	K	Z	M		
X51-125	125	65	18	80	105	2	4	M8	16(4+12) 或 8(4+4)	5.6
X51-150	150	65	18	110	130	2	4	M8		8
X51-160	160	65	18	120	140	2	4	M8		10
X51-200	200	65	20	160	180	2	4	M10		18
X51-250	250	65	20	200	224	4	4	M10		28
X51-300	300	65	20	230	260	4	4	M10		35
X51-350	350	65	22	260	310	4	4	M12		45
X51-400	400	70	22	300	360	4	6	M12		60
X51-450	450	70	25	350	410	4	6	M12		78
X51-500	500	70	25	380	440	4	6	M12		97
X51-600	600	75	25	480	540	4	6	M12	150	

更多规格可根据客户需求制作。

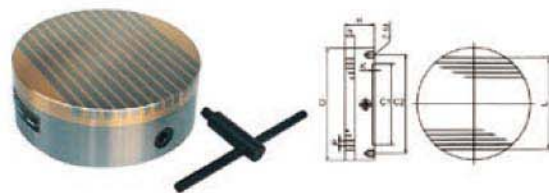

► XF51辐射圆形永磁吸盘

产品介绍：辐射极圆形永磁吸盘适用于小型立式平面磨床、外圆磨床、内圆磨床的磨削加工、车床的轻度切削加工。

Product introduction: the circular permanent magnet suction cup is suitable for the grinding process of small vertical plane grinder, cylindrical grinder, internal grinder and lathe. The whole panel structure can keep the disk with high precision and small change.

产品规格：

型号	主要尺寸								磁极形式	净重KG
	D1	H	h	D2	D3	K	n	M		
XF51-150	150	76	18	110	130	4	4	M8	辐射板	8
XF51-160	160	76	18	120	140	4	4	M8		10
XF51-200	200	76	18	160	180	4	4	M10		18
XF51-250	250	76	18	200	224	4	4	M10		28
XF51-300	300	76	18	230	260	4	4	M10		35
XF51-350	350	80	20	260	310	4	4	M12		45
XF51-400	400	80	20	300	360	4	6	M12		60
XF51-450	450	80	20	350	410	6	6	M12		75
XF51-500	500	90	25	380	440	6	6	M12		145
XF51-600	600	90	25	480	540	6	6	M12		210

更多规格可根据客户需求制作。

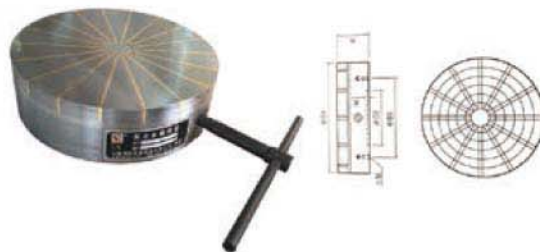

► X61铣削强力电永磁吸盘

产品介绍：强力电永磁吸盘是用电脉冲来“开和关”磁力的新型磁力吸盘。电永磁吸盘在工作中不需要电能，只是在充磁和消磁过程的 1—2 秒内使用电能。由于加工过程中无需电源，不会出现发热现象、无热变形，即经济又环保。即便是加工过程中突然停电，也不会失磁，工件也不会移动。此系列磁盘，既有“电磁吸盘”的方便操作性，又有“永磁吸盘”的安全精度性，是高精度加工不可缺少的利器。强力电永磁吸盘适合于高精度磨削、铣削等精密加工。

Product introduction: electric permanent magnetic chuck is a new type of magnetic force, which is used to 'open and close' magnetic force. The electric permanent magnet sucker at work without electricity, only in the magnetization and degaussing process of 1 - 2 seconds using electricity. Even if it is a sudden power outage in the process, it will not be lost, the workpiece will not move.

产品特点：

- 1、安全，断电 30 年不失磁；
- 2、能，节电 95% 以上；
- 3、效，提高效率 60% 以上
- 4、持力可高达 20Kg/cm² 以上
- 5、用非常简便、快捷，经久耐用，免维护

Product features:

- 1, fety, do not break the magnetic power 30 years;
- 2, nergy saving, and the saving electricity was above 95%;
- 3, gh efficiency, and improve the efficiency of more than 60%;
- 4, he clamping force can be as high as more than 20 kg/cm²
- 5, ery easy to use, fast, durable, maintenance free

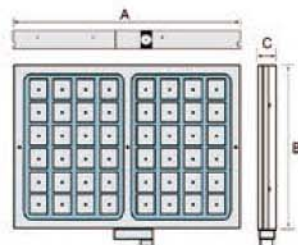

各式加工範例

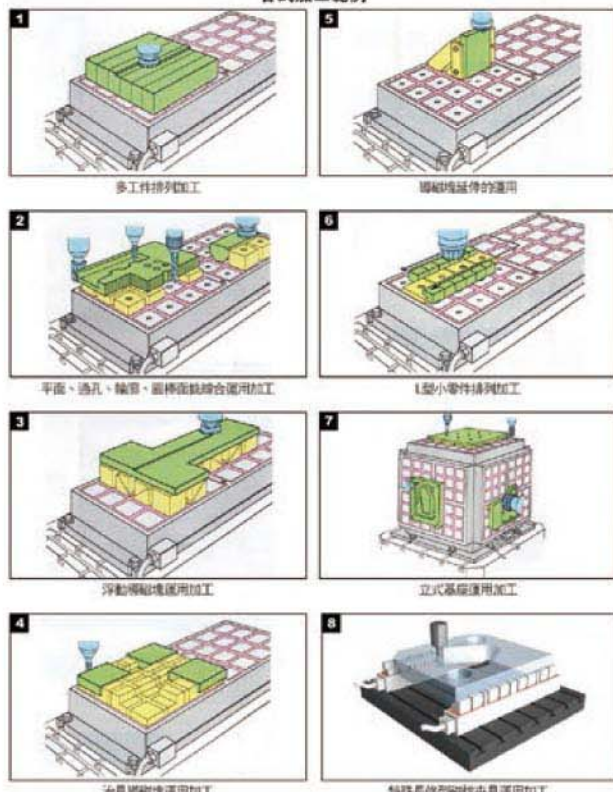

產品規格：

型号 Model	主要尺寸mm			磁极 (数量)		净重 KG
	长A	宽B	高C	70*70	50*50	
X61-250*250	250	250	68	4	9	30
X61-250*300	300	250	68	6	12	36
X61-300*300	300	300	68	9	16	43
X61-300*400	400	300	68	12	20	57
X61-300*500	500	300	68	15	28	72
X61-300*600	600	300	68	18	32	86
X61-300*800	800	300	68	24	48	115
X61-300*1000	1000	300	68	30	60	144
X61-400*400	400	400	68	16	25	76
X61-400*500	500	400	68	20	35	96
X61-400*600	600	400	68	24	40	115
X61-400*800	800	400	68	32	60	153
X61-400*1000	1000	400	68	40	75	192
X61-500*500	500	500	68	25	49	120
X61-500*600	600	500	68	30	56	144
X61-500*800	800	500	68	40	84	192
X61-500*1000	1000	500	68	50	105	240
X61-600*600	600	600	68	36	72	172
X61-600*800	800	600	68	48	96	230
X61-600*1000	1000	600	68	60	120	288
X61-600*1200	1200	600	68	72	144	345
X61-600*1500	1500	600	68	90	176	432

备注：其他规格可按用户要求定制，详情请来电咨询。
 使用建议：有两种安装方式（通孔/压块），请根据安装方式选购产品。

▶ X62磨床电永磁吸盘

产品介绍：电永磁吸盘适用于平面磨床、CNC、电火花机床吸附各种导磁工件进行加工，吸力均匀，加工精度高，适用加工薄小工件。由于加工过程中无需电源，不会出现发热现象、无热变形，即经济又环保。即便是加工过程中突然停电，也不会失磁，工件也不会移动当。

用户选购产品时，可以选购横向密极电永磁吸盘或纵向密极电永磁吸盘。

Product introduction: electric permanent magnet sucker is suitable for surface grinder, CNC, adsorption of all kinds of magnetic conductive workpiece processing, suction uniform, high processing precision, applicable to the processing of thin small workpiece. Because the process is not required to supply power, even if it is a sudden power outage in the process, it will not be lost.

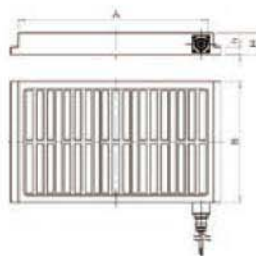

产品规格：

型号 Model	主要尺寸mm Dimensions				极距P	净重KG Net WT	包装箱外形尺寸CM Overall size
	长L	宽B	高H	h			
X62-150*400	400	150	65	20	22	27	58*25*13
X62-200*400	400	200	65	20	22	36	58*29*13
X62-200*560	560	200	65	20	22	51	76*29*13
X62-250*600	600	250	65	20	22	68	80*34*13
X62-300*600	600	300	65	20	22	82	80*38*13
X62-300*680	680	300	65	20	22	93	90*38*13
X62-300*800	800	300	65	20	22	110	100*40*13
X62-300*1000	1000	300	65	20	22	137	118*40*13
X62-300*1600	1600	300	68	25	22	230	178*40*13
X62-320*800	800	320	65	20	22	117	98*42*13
X62-320*1000	1000	320	65	20	22	146	118*42*13
X62-320*1250	1250	320	68	25	22	192	145*42*13
X62-320*1600	1600	320	68	25	22	246	178*42*13
X62-400*800	800	400	68	25	22	153	98*50*13
X62-400*1000	1000	400	68	25	22	192	118*50*13
X62-400*1200	1200	400	68	25	22	230	138*50*13
X62-400*1600	1600	400	68	25	22	307	178*50*13
X62-500*800	800	400	68	25	22	192	98*60*13
X62-500*1000	1000	500	68	25	22	240	118*60*13
X62-500*1200	1200	500	68	25	22	288	138*60*13
X62-500*1600	1600	500	68	25	22	380	178*60*13
X62-600*1000	1000	600	68	25	22	288	118*70*13
X62-600*1200	1200	600	68	25	22	345	138*70*13
X62-600*1600	1600	600	68	25	22	460	178*70*13

备注：其他规格可按用户要求定制，详情请来电咨询。
 使用建议：有两种安装方式（通孔/压块），请根据安装方式选购产品。

► X71圆形电永磁吸盘

产品介绍: 圆形电永磁吸盘采用多磁路电控设计, 磁力可调, 充磁后无需继续供电, 可通过快速接头或导电滑环供电。在加工过程中, 工件夹持无障碍, 可以自由加工工件, 真正发挥1次装夹完成3面加工功能;

安全保证, 短时瞬间通电充退磁, 因此不会因加工过程中突然断电或停电导致工件飞出;

精度保障, 线圈不发热, 磁盘无热变形, 保证加工精度;

快速定位, 可在磁极上的导磁块加工“T”形槽和钻孔, 可实现工件快速定位。

低振动夹持, 工件的夹持变形和振动极低, 表面光洁度提升, 精度显著提高;

无变形夹持, 工件内不会因为夹持力而产生变形和应力;

适用零件, 适用于不易装夹的工件(如薄壁件、法兰件、异形件等);

强大的吸持力, 吸力 $\geq 180\text{N}/\text{cm}^2$, 高刚性、高精度, 无热变形;

应用领域, 主要配套于卧式车床、立式车床、立式磨床、车铣复合、5轴机加工中心等;

兼容性能, 控制单元与机床控制系统兼容, 也可用于自动化应用;

使加工过程更安全, 便捷, 高效。

Product introduction: The circular electro-permanent magnet chuck is designed with multi-magnetic circuit and electric control. Its magnetic force is adjustable. It does not need to continue to supply power after magnetization. It can supply power through fast joint or conductive sliding ring. In the process of processing, the workpiece clamping is barrier-free, and can process the workpiece freely. It can really play the function of one clamping to complete three-sided processing.



产品规格:

型号 Model	主要尺寸 mm			磁极数	通道数	电压V Voltage	最大RPM [1/min]	净重KG Net WT	包装箱尺寸CM Overall size
	Φ D	Φ d	H						
X71-400	400	60	100	12	1	220/480	1000	98	50*50*20
X71-500	500	60	100	12	1	220/480	800	150	60*60*20
X71-600	600	80	100	12	1	220/480	650	220	70*70*20
X71-700	700	80	110	12/16	2	220/480	600	290	80*80*22
X71-800	800	120	110	12/16	2	220/480	500	390	90*90*22
X71-1000	1000	200	120	16/24	2	220/480	400	660	110*110*22
X71-1200	1200	250	120	16/24	2	220/480	320	950	130*130*22
X71-1400	1400	300	130	18/24	4	220/480	260	1400	150*150*25
X71-1600	1600	400	130	24/32	4	220/480	240	1850	170*170*25
X71-1800	1800	500	130	24/32	4	220/480	160	2300	190*190*25
X71-2000	2000	600	135	24/36	6	220/480	128	2900	210*210*26
X71-2500	2500	800	135	36/48	8	220/480	100	4500	268*268*26
X71-3000	3000	800	140	36/48	8	220/480	80	6800	318*318*26
X71-3500	3500	1000	140	48/60	10	220/480	60	9500	368*368*26

备注: 其他规格可按用户要求定制; 详情请来电咨询。

使用建议: 有两种接电方式(快插/导电滑环), 请根据安装方式选购产品;

▶ 玻璃夹具电永磁吸盘

产品介绍：触摸屏玻璃专用 - 电永磁吸盘，适用于加工手机触屏玻璃、平板电脑触屏玻璃... 等，加工玻璃产品时可多层式装夹，可以一次叠起 2~5 片玻璃件同时加工，比起传统的真空吸盘一次只能加工单片，提高了 2~5 倍的效率与产量！专门针对移动手机玻璃（如 iPhone 面板玻璃），平板电脑玻璃（如 iPad 面板玻璃），及其它显示面板玻璃，如 GPS 导航仪的触摸屏面板玻璃以及高档电器开关面板玻璃等加工，为电容屏触控板以及电阻屏基板的成型加工提供高效率的装夹解决方案。

Product introduction:carved machine grinding, tablets, mobile phone touch screen glass touch screen glass special efficient fixture, special - electric permanent magnet disc grinding touch screen glass, suitable for processing, tablets, mobile phone touch screen glass touch screen glass..., such as multi-layer clamping when processing glass products, can be a handful of 2 - 5 pieces of glass processing at the same time, compared with the traditional vacuum, a clamping one or only a layer of glass processing, improve the yield and efficiency of 2 ~ 5 times!

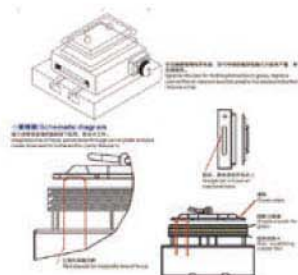
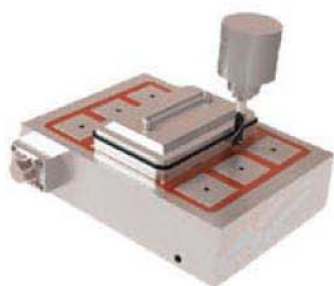

▶ 导轨电永磁吸盘

产品介绍：

1. 本系列适用于小、中、大型尺寸之高精度线轨或长条型工件使用。
2. 本产品搭配导磁软爪使用，可提高线轨研磨精度。
3. 电控式结构设计：1 ~ 3 秒钟充、退磁，使用时不须持续供电，无温升、可长时间使用，不会因温度升高导致工件变形影响精度。

Product introduction:

1. This series is suitable for small, medium and large size high precision line rail or strip shape workpiece.
2. This product is tie-in use permeability soft claw, line rail grinding accuracy can be improved.
3. The electrical structure design: 1 ~ 3 seconds, demagnetization, need not when using continuous power supply, no temperature rise, can be used for a long time, not influence precision of the workpiece deformation caused by temperature rise.



▶ 道岔电永磁吸盘

产品介绍：专目前国内大力建设轨道工程，道岔需求量急剧上升。我公司可根据用户要求设计制作针对道岔和铁轨加工的道岔专用加工电永磁吸盘。

根据客户要求，多台吸盘组合对各种轨道进行加工，专业的控制系统可以通过操作台按钮对所有吸盘进行统一充退磁控制或分区充退磁控制。我公司设计制作的吸盘组合吸力极大，完全满足道岔加工时的大扭力力量重切削需求；吸盘结构简单紧凑，安装方便，安全系数大。

Product introduction: according to customer requirements, we can design and manufacture special processing electric permanent magnet sucker for turnout and rail processing. The track for processing multiple suction combination, professional control system can be unified demagnetization demagnetization control or partition to control all disks through the console button.

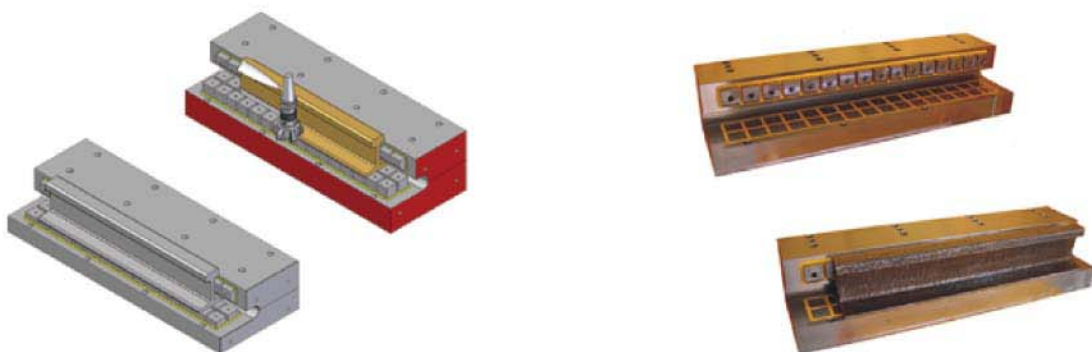

▶ 电永磁脉冲式控制器

产品介绍：

安全保护：可通过解锁输入触点信号和充磁状态输出触点实现主轴联动，设有可调的充（退）磁电流过流（或短路）保护与欠流（或断路）报警功能，电永磁吸盘只在充（退）磁瞬间与电源连接；

操作简单：所有设置参数与运行状态均可通过主机面板实行监控，并具有电源频率自动跟踪功能；配置灵活，使用方便。

控制接口：设有多种可选的控制接口，满足各种联机控制要求，具有可选的远程（遥）控制或 PLC 接口。

Product introduction:

safety protection: can unlock the input contact the magnetization state output signal and the contact spindle linkage, is equipped with adjustable (back) magnetolectric filling through the flow or short circuit protection and low flow (or breaking) warning function, electric permanent-magnetic chuck only in charge (back) magnetic moment and the power connection;

The operation is simple: all set parameters and running status can be monitoring by host panel, and has the function of power frequency automatic tracking; Flexible configuration, easy to use.

单路



双路



四路



合模



▶ 注塑机电永磁电控

产品介绍：电控永磁快速换模系统主要是针对传统注塑机、冲床、合模机装夹模具时间长，操作复杂，安全性低而设计的，该系统采用电控永磁模单的充退磁动作，就能装夹和更换模具，真正做到3分钟换模，它既可以安装到新机中，作为标准配置销售给最终客户，也可以对正在使用机台进行改造，使传统机台具有3分钟快速换模功能而不会改变原来机台的结构，即实用又方便。

Product introduction: electric control permanent magnet quick die change system is mainly aimed at the traditional injection molding machine, punching machine, mold clamping machine clamping mould time is long, complex operation, low safety and design, the system adopts the electric control permanent magnet templates and dynamic template, only by simple filling demagnetization action, can replace the clamping and mold, truly 3 minutes in die.

01 预留孔 /Reserved holes
 预留全部模具顶出孔
 Reserved all mold ejector holes

02 基板 /Base plate
 由整块钢板加工而成，刚性更高
 Be composed of one-piece steel plate,
 higher stiffness

03 集线盒 /Wiring box
 设计合理，便于维护
 Reasonable design, easy to maintain

04 接近微距传感器 /Proximity switch sensor
 用于检测有无模具及背板和磁力模板之间的间隙。
 主动预警，位移超过 0.2mm 立即停机报警，确保
 人员、设备和模具的绝对安全
 Used for measuring the gap between
 the electrical Permanent magnet
 platen and the mold back plate, alarm
 at once when the gap larger than 0.2
 mm, ensure staff, equipment and mold
 safety

05 磁通量传感器 /Flux sensor
 检测磁饱和强度
 Check magnet saturation

06 较低的树脂平面 /Lower resin surface
 具有高阻抗和耐高温的环氧树脂密封，有效避免热膨胀造成的影响
 High resistance and hi-temperature
 resistant

07 扩展板 /Extension plate
 可预留滚轮加工孔，用于侧向换模
 Reserved holes for roller, used for side
 leading

08 中心定位环 /Centering ring
 用于快速定位模具
 used for locating mold quickly

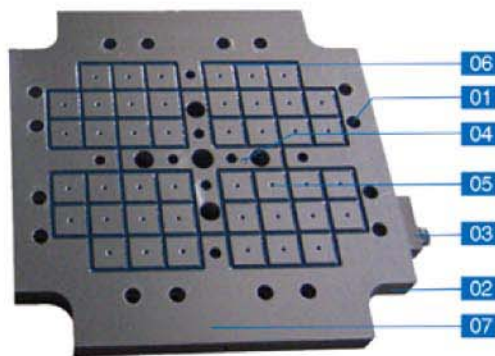
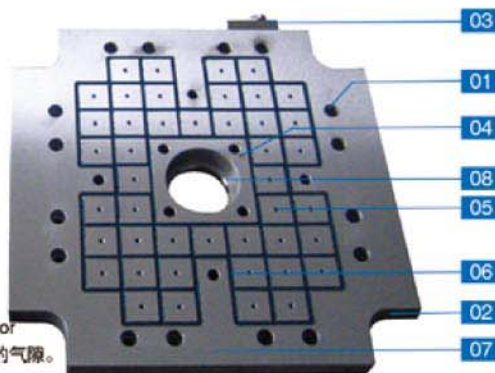

产品规格：

注塑机锁模力 (T)	磁模板大概尺寸 (mm)			每个模板的磁极数量	每个模板的吸力
	A	B	厚度		
50	540	540	52	8	6000
80	600	600	52	11	8250
100	600	600	52	13	9750
125	660	690	52	15	11250
150	750	750	52	19	14250
200	830	830	52	22	16500
250	950	950	52	33	24750
300	950	950	52	33	24750
350	950	1050	52	44	33000
420	1100	1200	52	52	39000
500	1200	1300	52	64	48000
650	1350	1450	52	102	76500
800	1500	1600	52	118	88500
1000	1700	1900	52	150	1E+05
1300	1900	2200	52	201	2E+05
1500	2000	2400	52	260	2E+05
2000	2300	2600	52	329	2E+05
2300	2400	2850	52	385	3E+05
2700	2600	3050	52	454	3E+05
3200	2600	3050	52	454	3E+05
4000	2950	3300	52	641	5E+05

► 电(永)吸盘导磁块

产品介绍：导磁块采用全新工艺，六面精磨加工，主要用于对各种电磁 / 永磁吸盘的延伸。主要分为密极型，中目型，粗目型导磁块和超宽型导磁块。无论什么样的导磁块极距一定要和使用中的极距相符合才能使用，否则会发生导磁块不延伸磁力或者磁力延伸比较微弱的等状况。

Product introduction: new technology on permeability blocks, six surface grinding, it is mainly used for the extension of various electromagnetic, permanent magnetic chuck. Mainly divided into dense type, mesh type, coarse mesh type magnetic blocks and ultra wide type magnetic blocks. No matter what kind of magnetic pole pitch block must be consistent and use the pole pitch to use, otherwise it will occur or magnetic permeability block not extend magnetic extending a weak light condition.



► 电永磁吸盘导磁块

产品介绍：通过导磁块可实现六面一次性加工、打孔、定位等；对于毛坯、异形工件可通过弹性块上下浮动来适应工件平整度，提供更大的磁力，减少装夹次数，降低吸盘损耗。

Product introduction: through magnetic block can realize six sides one-time processing, punching, positioning, etc.; For blank, special-shaped workpiece can be floating up and down through the elastic block to adapt to the workpiece roughness, provide greater magnetic force, decrease The Times of the clamping and reduce the loss of suction cups.



方形固定导磁块

型号	规格	高度
H50-25		25
H50-30	50×50	30
H50-30		50
H70-25		25
H70-30	70×70	30
H70-70		70



方形带台阶固定导磁块

型号	规格	高度
HF50-25		25
HF50-30	50×50	30
HF50-30		50
HF70-25		25
HF70-30	70×70	30
HF70-70		70



弹性方形导磁块

型号	规格	高度
ES50-32		29-32
ES50-50	50×50	47-52
ES70-45		48-52
ES70-70	70×70	66-72



圆形固定导磁块

型号	规格	高度
CH50-25		25
CH50-30	∅50	30
CH50-50		50
CH70-25		25
CH70-30	∅70	30
CH70-70		70



圆形带台阶固定导磁块

型号	规格	高度
CHF50-25		25
CHF50-30	∅50	30
CHF50-50		50
CHF70-25		25
CHF70-30	∅70	30
CHF70-70		70



圆形弹性导磁块

型号	规格	高度
CHS50-32	∅50	29-34
CHS70-45	∅70	42-48



固定导磁板

型号	规格	高度
HMB50-25		25
HMB50-30	50×50	30
HMB50-50		50
HMB70-25		25
HMB70-30	70×70	30
HMB70-70		70



带台阶固定导磁板

型号	规格	高度
HMF50-25		25
HMF50-30	50×50	30
HMF50-50		50
HMF70-25		25
HMF70-30	70×70	30
HMF70-70		70



V型导磁板

型号	规格	高度
HV50-90	50×50	90
HV50-120		120
HV70-90	70×70	90
HV70-120		120



扫一扫 关注翔源



无锡翔源机械设备有限公司

WUXI XIANGYUAN MACHINERY EQUIPMENT CO.,LTD.

地 址：无锡市惠山区洛社镇双庙工业园
电 话：0510-88233906 / 88153158 / 88848008
传 真：0510-88550110
邮 箱：wxxiangyuan@163.com
网 址：www.wxxiangyuan.com

(最终解释权归本公司所有)

address: Luoshe Industrial Park, Huishan District, Wuxi City
Tel: 0510-88233906 / 88153158 / 88848008
Fax: 0510-88550110
E-mail: sales@wx-gb.com
http:// www.wxxiangyuan.com